

CD85N20-60-B

Scheda tecnica

specifiche standard

Anello magnetico	anello magnetico incorporato
Montaggio	Esecuzione Base con Cerniera Integrata
Diametro	20mm
Corsa	60 mm
Ammortizzo	Paracolpi elastici
Soffietto protezione stelo	Nessuno
Tipo montaggio sensore magnetico	a fascetta
Peso	0.254 kg

Dimensioni

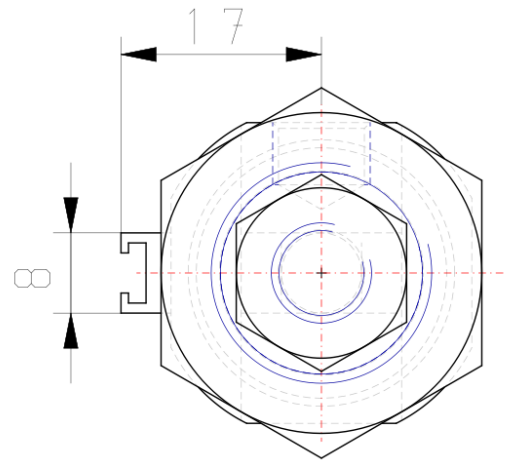
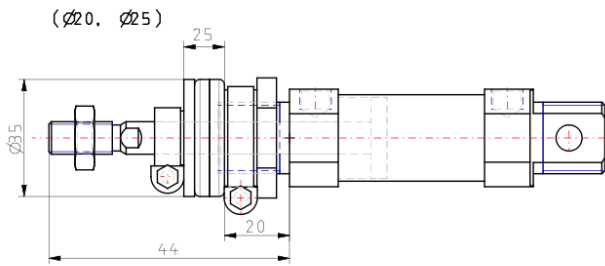
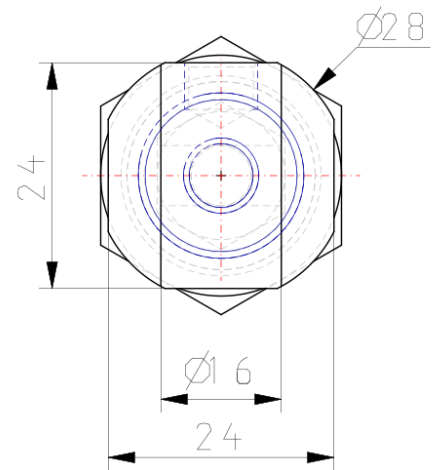
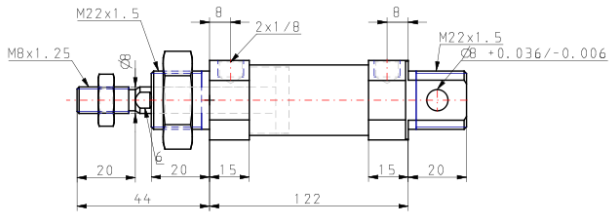

Prodotti correlati



D-M9N
D-**PC, Sensori con connettore pre-cablato



D-M9NW
D-**PC, Sensori con connettore pre-cablato



D-A96
A90/A93/A96, Sensori reed, Montaggio diretto, Grommet, In linea



AS2201F-G01-06SA
AS*2/3*1F-A, Regolatore di flusso con raccordo istantaneo, Tipo bloccabile, Tipo Gomito/Universale



AS2301F-G01-06SA
AS*2/3*1F-A, Regolatore di flusso con raccordo istantaneo, Tipo bloccabile, Tipo Gomito/Universale



AS2002F-06A
AS*2F-A, Regolatore di flusso con raccordi istantanei, Tipo in linea, Tipo bloccabile



KQ2H06-G01AS
KQ2H, raccordo istantaneo colore bianco - D'estremità diritto



TU0604BU-20
TU, tubi in poliuretano, sistema metrico



AR
AR10-60, regolatore modello modulare



SY
SY3000/5000/7000, Sottobase singola, Conforme a IP67



RB
RB, deceleratore idraulico