

Cerniera in plastica

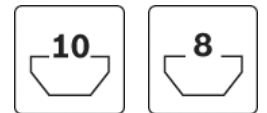

- Cerniera in plastica per profilati con scanalatura di 8 mm o di 10 mm
- Possibilità di montaggio su elementi di superficie massicci
- Perno di centraggio per un montaggio facile e in versione antitorsione

Descrizione del prodotto

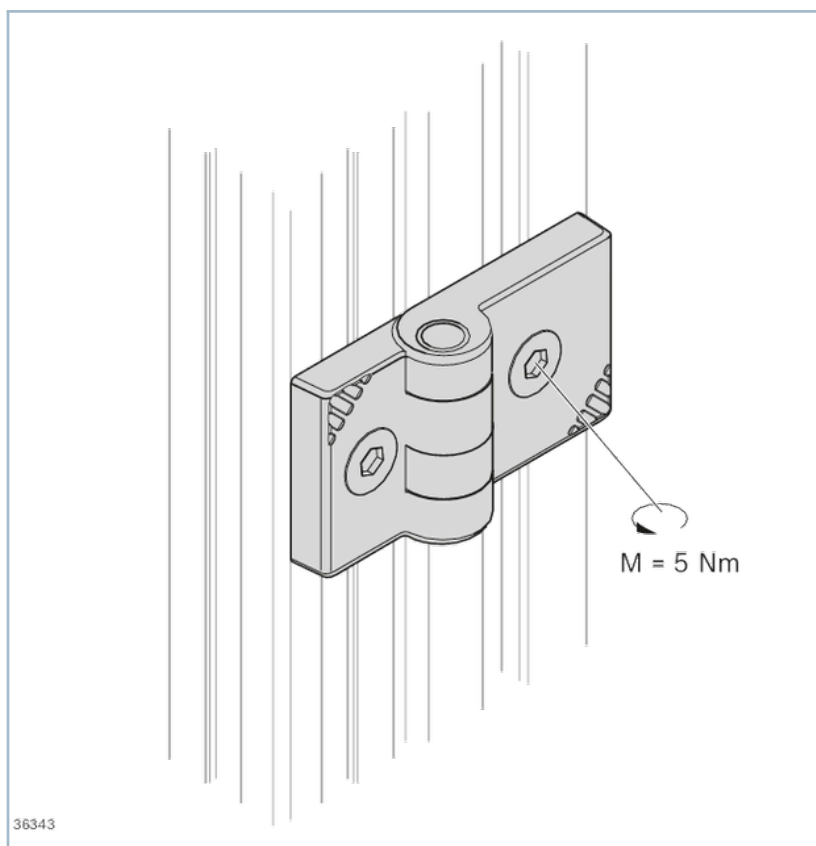

Dati tecnici

Scanalatura	
	N
8; 10	150

N.	Materiale
3842554458	
3842554460	PA; grigio segnale
3842554462	asse cerniera: acciaio; zincato Materiale di fissaggio: Acciaio; zincato
3842554464	

N.	Materiale
3842554466	PA; grigio segnale asse cerniera: acciaio; zincato Materiale di fissaggio: Acciaio; zincato
3842554468	
3842554470	
3842554472	

Dimensioni

Cerniera in plastica

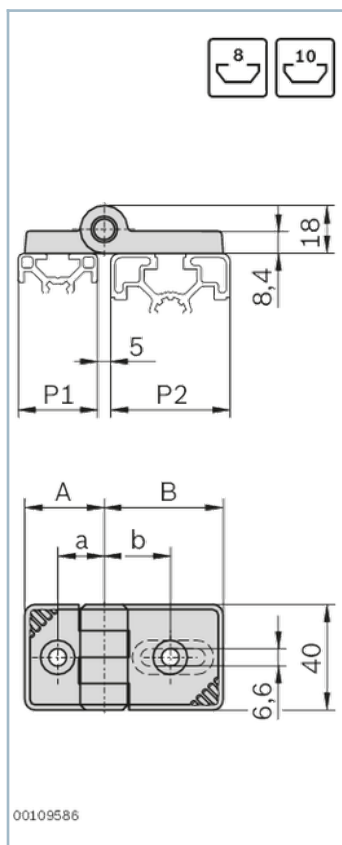





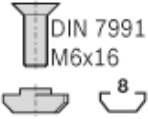

P2	P1	P1/P2	A/B	a/b
		mm	mm	mm
30	30	30	30	17,5
40/50				
45				
60				
40/50	40/50	40	39	22,5
45	45	45	45	25
60				

P2	P1	P1/P2	A/B	a/b
		mm	mm	mm
60	60	60	60	32,5

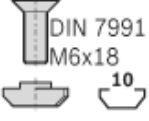
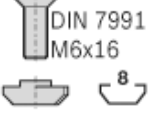
Note relative alla consegna

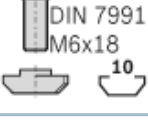
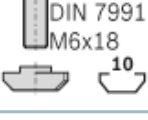
Materiale di fissaggio

3842554458	2x			
3842554460	1x		1x	
3842554462	1x		1x	
3842554464	1x		1x	
3842554466	2x			
3842554468	2x			
3842554470	2x			
3842554472	2x			

Fornitura

Cerniera in plastica P1=30 P2=30	Incl. materiale di fissaggio (FS)
Cerniera in plastica P1=30 P2=40/50	
Cerniera in plastica P1=30 P2=45	
Cerniera in plastica P1=30 P2=60	
Cerniera in plastica P1=40/50 P2=40/50	

Cerniera in plastica P1=45 P2=45	Incl. materiale di fissaggio (FS)
Cerniera in plastica P1=45 P2=60	
Cerniera in plastica P1=60 P2=60	

Codici di ordinazione

	Scanalatura	P1	P2		FS	N.
Cerniera in plastica P1=30 P2=30	8; 10	30	30	2	2xFS1	3842554458
Cerniera in plastica P1=30 P2=40/50	8; 10	30	40/50	2	1xFS1, 1xFS2	3842554460
Cerniera in plastica P1=30 P2=45	8; 10	30	45	2	1xFS1, 1xFS2	3842554462
Cerniera in plastica P1=30 P2=60	8; 10	30	60	2	1xFS1, 1xFS2	3842554464
Cerniera in plastica P1=40/50 P2=40/50	8; 10	40/50	40/50	2	2xFS2	3842554466
Cerniera in plastica P1=45 P2=45	8; 10	45	45	2	2xFS2	3842554468
Cerniera in plastica P1=45 P2=60	8; 10	45	60	2	2xFS2	3842554470
Cerniera in plastica P1=60 P2=60	8; 10	60	60	2	2xFS2	3842554472